

TVS Diodes

Transient Voltage Suppression Diodes



Description

Transient Voltage Suppressor (TVS) is a circuit protection component that either attenuates (reduces) or filters a transient voltage spike (overvoltage), TVS diodes provide critical protection by going into avalanche breakdown within no more than a few nanoseconds after a strike, clamping the transient voltage, and routing its current to the ground.

Applications

- Communication Equipment
- Security & Protection
- Industrial Control Equipment
- Power Supply
- Automotive Electronics
- New Energy
- Lightning Protection

Functional Diagram

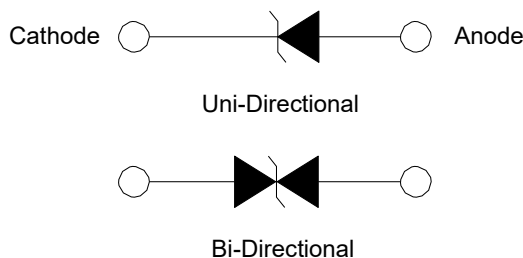

Features

- AEC-Q101 Qualified
- Low incremental surge resistance
- Excellent clamping capability
- Low profile package with built-in strain relief
- Typical I_R less than 1.0 μA above 12 V
- 400 W peak pulse power capability with a 10/1000 μs Waveform, repetition rate (duty cycle): 0.01%
- For surface mounted applications to optimize board space
- Typical failure mode is short from over-specified voltage or current
- IEC 61000-4-2 ESD 30 kV (Air), 30 kV (Contact)
- EFT protection of data lines in accordance with IEC 61000-4-4
- Very fast response time
- Glass passivated chip junction
- High temperature to reflow soldering guaranteed: 260 $^{\circ}C/40sec$
- $V_{BR} @ T_J = V_{BR@25^{\circ}C} \times (1 + \alpha T \times (T_J - 25))$
(αT : Temperature Coefficient, typical value is 0.1%)
- Plastic package is flammability rated V-0 per Underwriters Laboratories
- Meet MSL level1, per J-STD-020
- Matte tin lead-free plated
- Halogen free and RoHS compliant
- Pb-free E3 means 2nd level interconnect is Pb-free and the terminal finish material is tin(Sn) (IPC/JEDEC J-STD-609A.01)

TVS Diodes

Transient Voltage Suppression Diodes

ASMA Series

Package Outline Dimensions (DO-214AC)

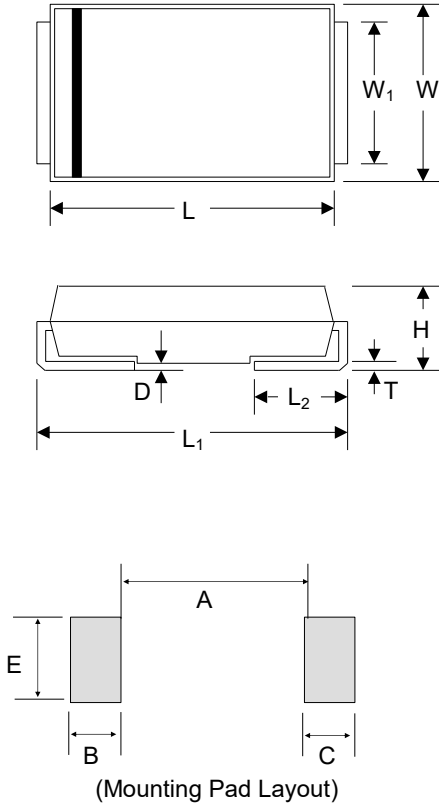

Symbol	Millimeters		Inches	
	Min.	Max.	Min.	Max.
L	3.99	4.60	0.157	0.181
W	2.30	2.79	0.095	0.110
W ₁	1.25	1.65	0.049	0.065
H	1.90	2.44	0.075	0.096
T	0.152	0.305	0.006	0.012
L ₁	4.80	5.28	0.189	0.208
L ₂	0.78	1.52	0.030	0.060
D	-	0.203	-	0.008
A	-	2.30	-	0.090
B	2.10	-	0.082	-
C	2.10	-	0.082	-
E	1.80	-	0.070	-

Maximum Ratings and Characteristics

(Ratings at 25 °C ambient temperature unless otherwise specified.)

Parameter	Symbol	Value	Unit
Peak Power Dissipation with a 10/1000 μ s waveform ⁽¹⁾⁽²⁾ (Fig.2)-Single Die Parts	P _{PPM}	400	W
Peak Power Dissipation with a 10/1000 μ s waveform ⁽¹⁾⁽²⁾ (Fig.2)-Stacked Die Parts ⁽⁵⁾	P _{PPM}	600	W
Peak Power Dissipation on Infinite Heat Sink at T _L =50 °C	P _D	3.3	W
Peak Forward Surge Current, 8.3 ms single half sinewave superimposed on rated load (JEDEC Method) ⁽³⁾	I _{FSM}	60	A
Maximum Instantaneous Forward Voltage at 25 A for Unidirectional Only ⁽⁴⁾	V _F	3.5/5.0	V
Operating Temperature Range	T _J	-65 to 150	°C
Storage Temperature Range	T _{STG}	-65 to 175	°C
Typical Thermal Resistance Junction to Lead	R _{θJL}	30	°C / W
Typical Thermal Resistance Junction to Ambient	R _{θJA}	120	°C / W

Notes:

1. Non-repetitive current pulse, per Fig. 4 and derated above T_J(initial)=25 °C per Fig. 3.
2. Mounted on 5.0 mm² land areas.
3. Measured of 8.3 ms single half sine-wave or equivalent square wave, duty cycle=4 pulses per minute maximum.
4. V_F < 3.5 V for single die parts and V_F < 5.0 V for stacked-die parts.
5. For stacked die component details, please refer to part numbers labeled by * in Electrical Characteristics.

TVS Diodes

Transient Voltage Suppression Diodes

ASMA Series

Part Numbering System

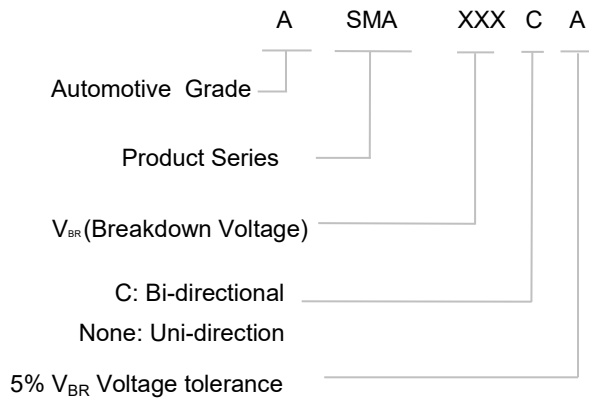

Marking

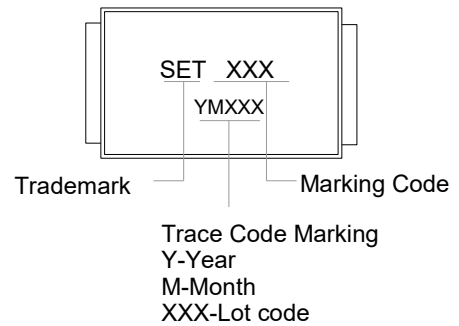
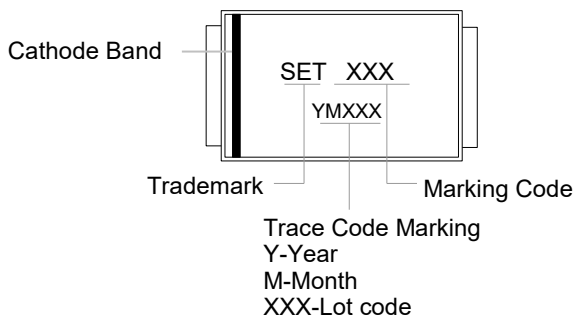

TVS Diodes

Transient Voltage Suppression Diodes

ASMA Series

Electrical Characteristics (T_A=25 °C unless otherwise noted)Table 1

Part Number		Device Marking Code		Breakdown Voltage V _{BR} @I _T		Test Current I _T	Reverse Stand-off Voltage V _R	Max. Reverse Leakage I _R @V _R	Max. Peak Pulse Current I _{PPM}	Max. Clamping Voltage V _C @I _{PPM}
				Min	Max					
Uni	Bi	Uni	Bi	(V)		(mA)	(V)	(μA)	(A)	(V)
ASMA6.8A	ASMA6.8CA	A6V8A	A6V8C	6.45	7.14	10	5.80	500.00	39.00	10.50
ASMA7.5A	ASMA7.5CA	A7V5A	A7V5C	7.13	7.88	10	6.40	250.00	36.30	11.30
ASMA8.2A	ASMA8.2CA	A8V2A	A8V2C	7.79	8.61	10	7.02	100.00	33.90	12.10
ASMA9.1A	ASMA9.1CA	A9V1A	A9V1C	8.65	9.55	1	7.78	25.00	30.60	13.40
ASMA10A	ASMA10CA	A10A	A10C	9.50	10.50	1	8.55	10.00	28.30	14.50
ASMA11A	ASMA11CA	A11A	A11C	10.50	11.60	1	9.40	5.00	26.30	15.60
ASMA12A	ASMA12CA	A12A	A12C	11.40	12.60	1	10.20	5.00	24.60	16.70
ASMA13A	ASMA13CA	A13A	A13C	12.40	13.70	1	11.10	1.00	22.50	18.20
ASMA15A	ASMA15CA	A15A	A15C	14.30	15.80	1	12.80	1.00	19.30	21.20
ASMA16A	ASMA16CA	A16A	A16C	15.20	16.80	1	13.60	1.00	18.20	22.50
ASMA18A	ASMA18CA	A18A	A18C	17.10	18.90	1	15.30	1.00	16.10	25.50
ASMA20A	ASMA20CA	A20A	A20C	19.00	21.00	1	17.10	1.00	14.80	27.70
ASMA22A	ASMA22CA	A22A	A22C	20.90	23.10	1	18.80	1.00	13.40	30.60
ASMA24A	ASMA24CA	A24A	A24C	22.80	25.20	1	20.50	1.00	12.30	33.20
ASMA27A	ASMA27CA	A27A	A27C	25.70	28.40	1	23.10	1.00	10.90	37.50
ASMA30A	ASMA30CA	A30A	A30C	28.50	31.50	1	25.60	1.00	9.90	41.40
ASMA33A	ASMA33CA	A33A	A33C	31.40	34.70	1	28.20	1.00	9.00	45.70
ASMA36A	ASMA36CA	A36A	A36C	34.20	37.80	1	30.80	1.00	8.20	49.90
ASMA39A	ASMA39CA	A39A	A39C	37.10	41.00	1	33.30	1.00	7.60	53.90
ASMA43A	ASMA43CA	A43A	A43C	40.90	45.20	1	36.80	1.00	6.90	59.30
ASMA47A	ASMA47CA	A47A	A47C	44.70	49.40	1	40.20	1.00	6.30	64.80
ASMA51A	ASMA51CA	A51A	A51C	48.50	53.60	1	43.60	1.00	5.80	70.10
ASMA56A	ASMA56CA	A56A	A56C	53.20	58.80	1	47.80	1.00	5.30	77.00
ASMA62A	ASMA62CA	A62A	A62C	58.90	65.10	1	53.00	1.00	4.80	85.00

TVS Diodes

Transient Voltage Suppression Diodes

ASMA Series

Part Number		Device Marking Code		Breakdown Voltage $V_{BR}@I_T$		Test Current I_T	Reverse Stand-off Voltage V_R	Max. Reverse Leakage $I_R@V_R$	Maxi. Peak Pulse Current I_{PPM}	Max. Clamping Voltage $V_C@I_{PPM}$
				Min	Max					
Uni	Bi	Uni	Bi	(V)		(mA)	(V)	(μ A)	(A)	(V)
ASMA68A	ASMA68CA	A68A	A68C	64.60	71.40	1	58.10	1.00	4.50	92.00
ASMA75A	ASMA75CA	A75A	A75C	71.30	78.80	1	64.10	1.00	4.00	103.00
ASMA82A	ASMA82CA	A82A	A82C	77.90	86.10	1	70.10	1.00	3.60	113.00
ASMA91A	ASMA91CA	A91A	A91C	86.50	95.50	1	77.80	1.00	3.30	125.00
ASMA100A	ASMA100CA	A100A	A100C	95.00	105.00	1	85.50	1.00	3.00	137.00
ASMA110A	ASMA110CA	A110A	A110C	105.00	116.00	1	94.00	1.00	2.70	152.00
ASMA120A	ASMA120CA	A120A	A120C	114.00	126.00	1	102.00	1.00	2.50	165.00
ASMA130A	ASMA130CA	A130A	A130C	124.00	137.00	1	111.00	1.00	2.30	179.00
ASMA150A	ASMA150CA	A150A	A150C	143.00	158.00	1	128.00	1.00	2.00	207.00
ASMA160A	ASMA160CA	A160A	A160C	152.00	168.00	1	136.00	1.00	1.90	219.00
ASMA170A	ASMA170CA	A170A	A170C	162.00	179.00	1	145.00	1.00	1.80	234.00
ASMA180A	ASMA180CA	A180A	A180C	171.00	189.00	1	154.00	1.00	1.60	246.00
ASMA200A	ASMA200CA	A200A	A200C	190.00	210.00	1	171.00	1.00	1.50	274.00
ASMA220A	ASMA220CA	A220A	A220C	209.00	231.00	1	185.00	1.00	1.30	328.00
ASMA250A	-	A250A	-	237.00	263.00	1	214.00	1.00	1.20	344.00
-	ASMA250CA*	-	A250C	237.00	263.00	1	214.00	1.00	1.20	344.00
ASMA300A	-	A300A	-	285.00	315.00	1	256.00	1.00	1.00	414.00
-	ASMA300CA*	-	A300C	285.00	315.00	1	256.00	1.00	1.00	414.00
ASMA350A*	ASMA350CA*	A350A	A350C	332.00	368.00	1	300.00	1.00	0.90	482.00
ASMA400A*	ASMA400CA*	A400A	A400C	380.00	420.00	1	342.00	1.00	0.80	548.00
ASMA440A*	ASMA440CA*	A440A	A440C	418.00	462.00	1	376.00	1.00	0.70	602.00
ASMA480A*	ASMA480CA*	A480A	A480C	456.00	504.00	1	408.00	1.00	0.61	658.00
ASMA510A*	ASMA510CA*	A510A	A510C	485.00	535.00	1	434.00	1.00	0.57	698.00
ASMA530A*	ASMA530CA*	A530A	A530C	503.50	556.50	1	451.00	1.00	0.55	725.00
AMSA540A*	AMSA540CA*	A540A	A540C	513.00	567.00	1	460.00	1.00	0.54	740.00
AMSA550A*	AMSA550CA*	A550A	A550C	522.50	577.50	1	468.00	1.00	0.53	760.00

Notes:

- For bidirectional type having V_R of 10 volts and less, the I_R should be doubled.
- For parts without A in the PN, the V_{BR} tolerance is $\pm 10\%$ and V_C is 5% higher than parts with A. The parts without A are currently available, but not recommended for new designs. The parts with A are preferred.
- For stacked die component details, please refer to models marked with * in electrical characteristics table.

TVS Diodes

Transient Voltage Suppression Diodes

ASMA Series

I-V Curve Characteristics

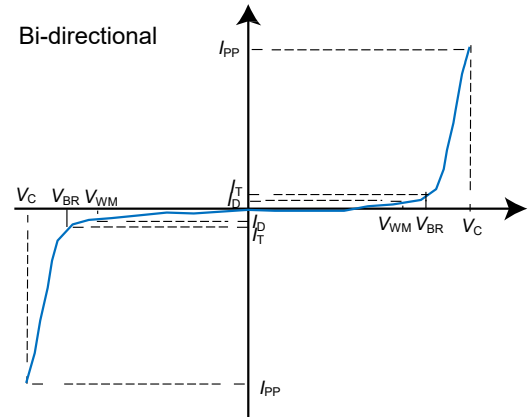
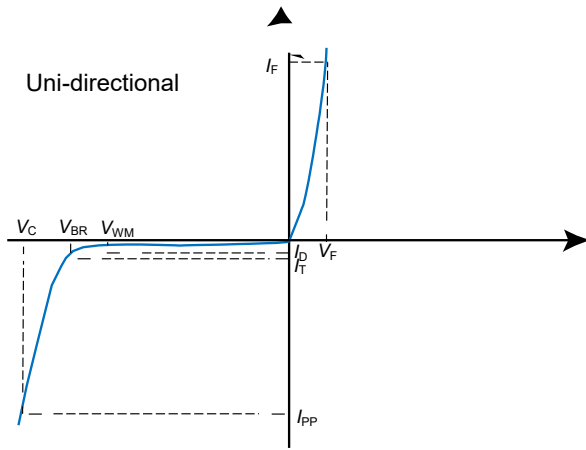

Performance Curve for Reference ($T_A=25^\circ\text{C}$ unless otherwise noted)

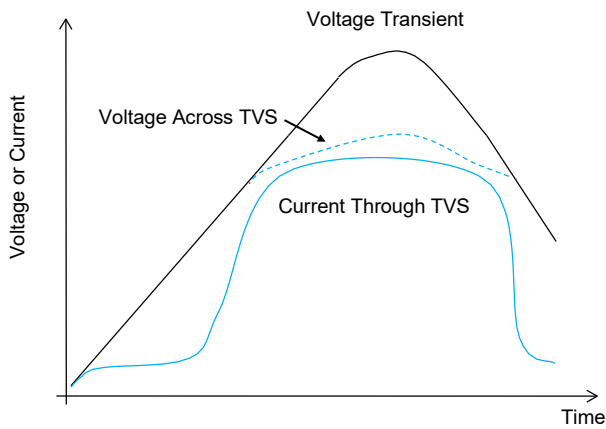

FIGURE 1 TVS Transients Clamping Waveform

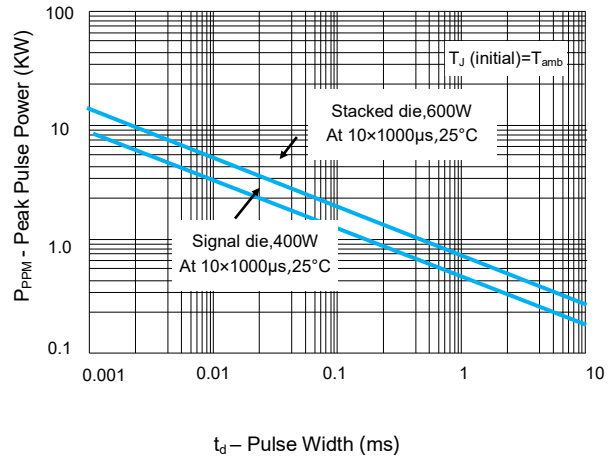

FIGURE 2 Peak Pulse Power Rating Curve

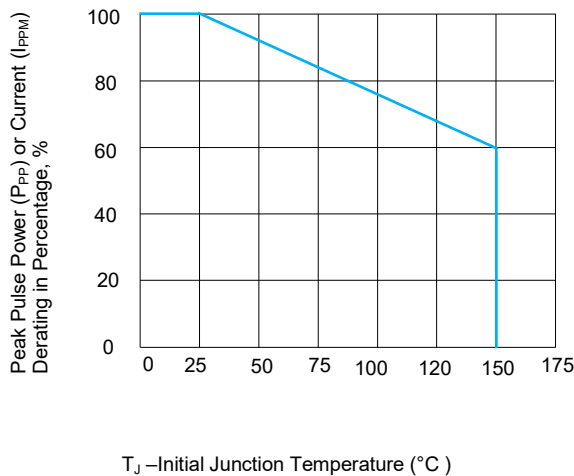

FIGURE 3 Peak Pulse Power Derating Curve

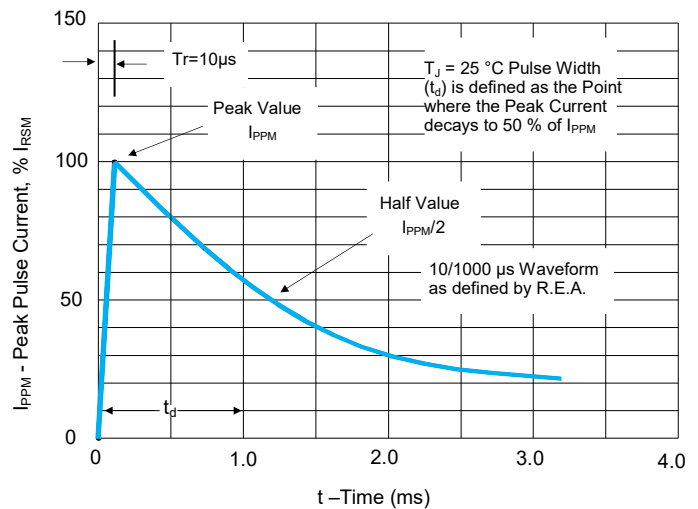

FIGURE 4 Pulse Waveform

TVS Diodes

Transient Voltage Suppression Diodes

ASMA Series

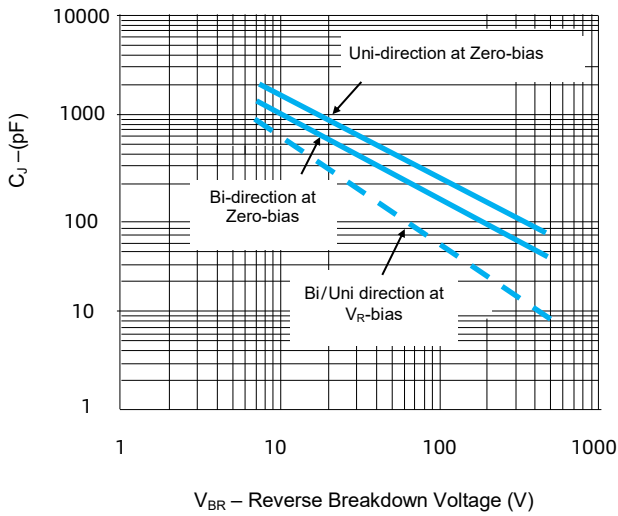

FIGURE 5 Typical Junction Capacitance

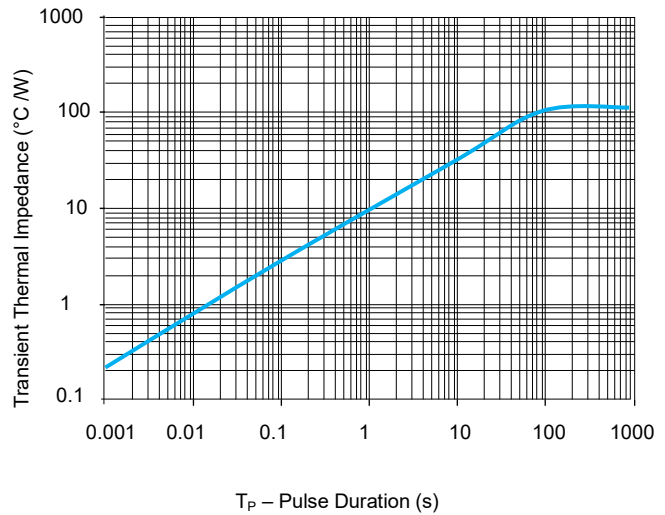

FIGURE 6 Typical Transient Thermal Impedance

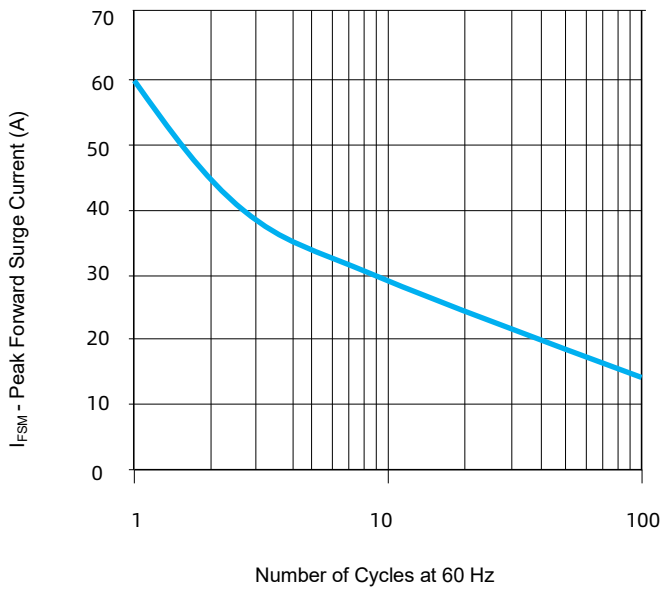

FIGURE 7 Maximum Non-Repetitive Forward Surge Current Uni-Directional only

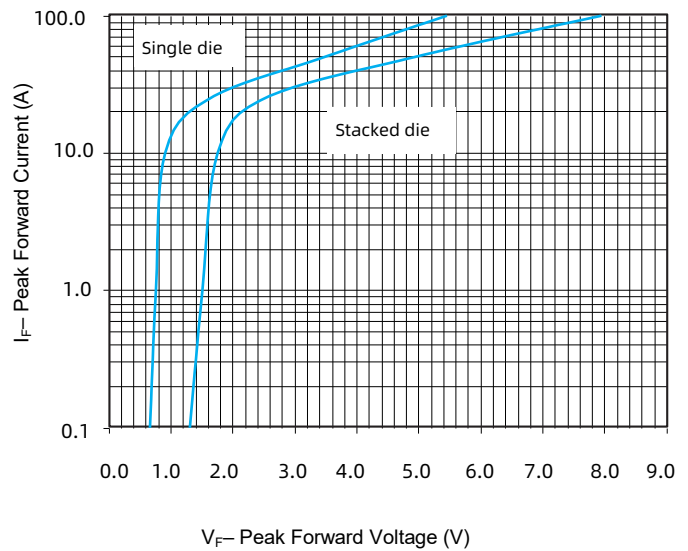

FIGURE 8 Peak Forward Drop vs Peak Forward Current (Typical Values)

Environmental Specifications

High Temp. Storage	JESD22-A103
HTRB	JESD22-A108
Temperature Cycling	JESD22-A104
MSL	JESDEC-J-STD-020, Level 1
H3TRB	JESD22-A101
RSH	JESD22-A111

Physical Specifications

Weight	0.002ounce,0.061grams
Case	JESD22DO214AC. Molded plastic body over glass passivated junction
Polarity	Color band denotes positive end (cathode) except Bidirectional
Terminal	Matte Tin-plated leads, Solderability per JESD22-B102

Soldering Parameters

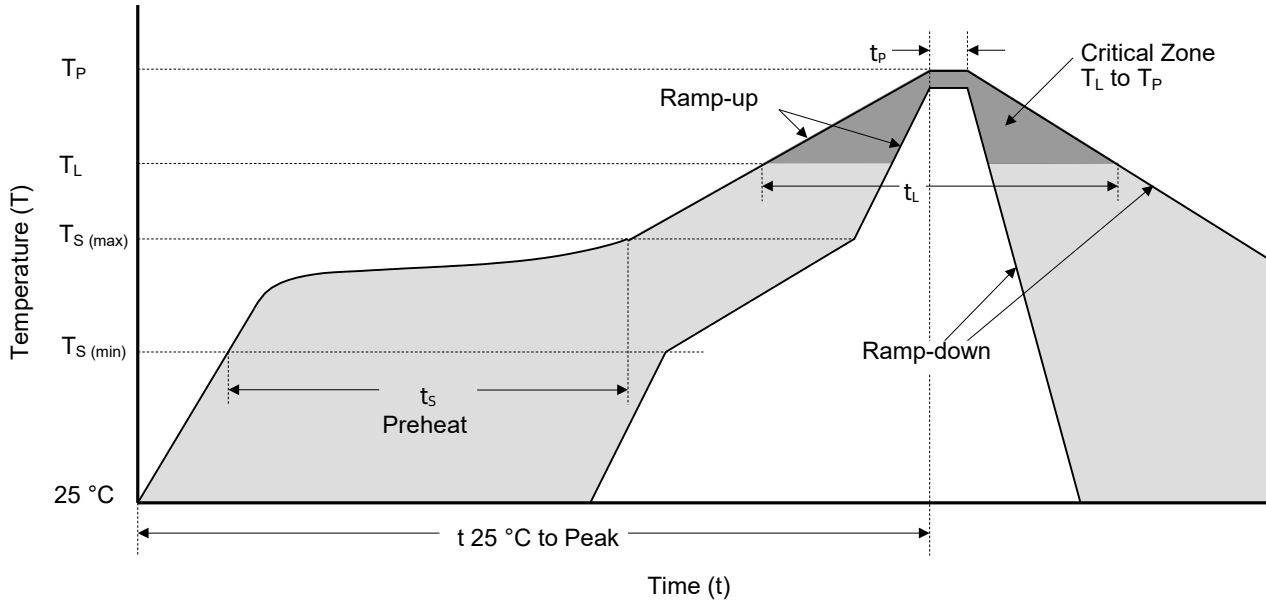

Reflowing Condition

Reflow Soldering Parameters		Lead-Free Assembly
Pre-heat	Temperature Min ($T_{S(min)}$)	150 °C
	Temperature Max ($T_{S(max)}$)	200 °C
	Time (min to max) (t_s)	60 ~ 120 seconds
Average Ramp Up Rate (Liquidus Temp (T_L) to Peak)		3 °C / second max.
$T_S(max)$ to T_L Ramp-up Rate		3 °C / second max.
Reflow	Temperature (T_L) (Liquidus)	217 °C
	Time (min to max) (t_L)	60 ~ 150 seconds
Peak Temperature (T_P)		260 ^{+0/-5} °C
Time of within 5 °C of Actual Peak Temperature (t_p)		20 ~ 40 seconds
Ramp-down Rate		6 °C / second max.
Time from 25 °C to Peak Temperature		8 Minutes max.
Do Not Exceed		260 °C

TVS Diodes

Transient Voltage Suppression Diodes

ASMA Series

Packaging Information

Tape	Symbol	Dimension (mm)
	W	12.00+0.30/-0.10
	P ₀	4.00±0.10
	P ₁	8.00±0.10
	P ₂	2.00±0.05
	D ₀	1.55±0.05
	D ₁	1.55±0.05
	E	1.75±0.10
	F	5.50±0.05
	A ₀	2.79±0.10
	B ₀	5.33±0.10
	K ₀	2.36±0.10
	T	0.30±0.05

Reel Size	13" Reel	
	A	330 mm
	C	13.2 mm
	W ₁	12.5 mm

Part Number	Package	QTY (Reel)	Packaging Option	Packaging Specification
ASMAxxx	DO-214AC	7500 PCS	Tape & Reel – 12 mm tape/13" reel	EIA STD RS-481

Glossary

Item	Description
V_C	Clamping Voltage Voltage across TVS in a region of low differential resistance that serves to limit the voltage across the device terminals.
V_R	Reverse Stand-off Voltage Maximum voltage that can be applied to the TVS without operation. NOTE : It is also shown as V_{WM} (maximum working voltage (maximum d.c. voltage)) and known as rated stand-off voltage (V_{so}).
I_R	Reverse Leakage Current Current measured at V_R . NOTE : Also shown as I_D for stand-by current.
V_{BR}	Breakdown Voltage Voltage across TVS at a specified current I_T in the breakdown region.
I_{PPM}	Rated Random Recurring Peak Impulse Current Maximum-rated value of random recurring peak impulse current that may be applied to a device.
$P_{M(AV)}$	Rated Average Power Dissipation Maximum-rated value of power dissipation resulting from all sources, including transients and standby current, averaged over a short period of time.
P_{PPM}	Rated Random Recurring Peak Impulse Power Dissipation Maximum-rated value of the product of rated random recurring peak impulse current (I_{PPM}) multiplies by specified maximum clamping voltage (V_C).
C_J	Capacitance Capacitance across the TVS measured at a specified frequency and voltage.
V_{FS}	Peak Forward Surge Voltage Peak voltage across an TVS for a specified forward surge current (I_{FS}) and time duration. NOTE : Also shown as V_F .
I_{FS}	Forward Surge Current Pulsed current through TVS in the forward conducting region. NOTE : Also shown as I_F .
$\alpha_{V(BR)}$	Temperature Coefficient of Breakdown Voltage The change of breakdown voltage divided by the change of temperature.
I_{PP}	Peak pulse Current Peak pulse current value applied across the TVS to determine the clamping voltage V_C for a specified wave shape.
I_T	Pulsed D.C. Test Current Test current for measurement of the breakdown voltage V_{BR} . This is defined by the manufacturer and usually given in milliamperes with a pulse duration of less than 40 ms. NOTE : Also shown as I_{BR} .

—(GB-T 18802.321 / IEC 61643-321 / JESD210A)



ATTENTION

Usage

1. TVS must be operated in the specified ambient temp.
2. Do not clean the TVS with strong polar solvent such as ketone, esters, benzene and halogenated hydrocarbon, to avoid damaging the encapsulating layer.
3. Please do not apply severe vibration, shock or pressure to TVS, to avoid element cracking.

Replacement

1. If TVS is visually damaged, please replace it.
2. TVS is a non-repairable product. For safety sake, please use equivalent TVS for replacement.

Storage

1. Storage Temp. Range: (-55 to 150) °C.
2. Do not store the TVS at the high temp., high humidity or corrosive gas environment, to avoid influencing the solder- ability of the lead wires. The product shall be used up within 1 year after receiving the goods.

Environmental Conditions

1. TVS should not be exposed to the open air, nor direct sunshine.
2. TVS should avoid rain, water vapor or other condition of high temp. and high humidity.
3. TVS should avoid sand dust, salt mist, or other harmful gases.

Max. Typical Capacitance of TVS

The typical capacitance of TVS is listed in the specifications. Designers may refer to it when designing TVS in High frequency circuit.

Installation Mechanical Stress

1. Do not knock TVS when installing, to avoid mechanical damage.
2. Please do not apply severe vibration, shock or pressure to TVS, to avoid surface resin or element cracking.

Automotive TVS Diodes (Surface Mount) Feature Overview

Package Type	Series													
	DO-214AA	DO-214AB	DO-214AC	DO-218AB	ASMB	ASMB-VR	ASMC	ASMC-VR	ASMD	A5.0SMD	SM8SxxA	SM8SxxCA	SM8TxxA	SM8TxxCA
Product Outline (mm)														
V_R / V_{WM} (V) Reverse Stand-off Voltage	5.8 ~ 468	5.0 ~ 440	5.8 ~ 553	5.0 ~ 440	5.8 ~ 51	5.0 ~ 440	12.0 ~ 170	10.0 ~ 43.0	12.0 ~ 43.0	20.0 ~ 43.0	33.0 ~ 36.0			
P_{PPM} (W) (10/1000 μ s) Rated Peak Impulse Power Dissipation	400		600		1500				3000	5000	6600		8000	
Operating Temperature ($^{\circ}$ C)	-55 to +150										-55 to +175			